

QUALITY COMPONENTS



3DL and 5-Piece doors, drawers and more



ABOUT US



Established in the early 70's as a finished cabinet company specializing in kitchen cabinetry, we bring a unique skill set to the business of component manufacturing.

Our strong cabinet-making background allows us to knowledgeably assist you throughout the ordering and engineering process. Not only that, our years of experience partnered with the latest developments in technology, materials and processes deliver a wealth of innovative, engineered wood products.

Shorter than average lead times, excellent partners and an experienced, stable workforce means delivery isn't an issue for us. We know what we need to do to get the job done right and on time. In fact, we pride ourselves on delivering the highest quality wood components at an industry-leading pace.

Profiles, colors, textures, glass installation, hinge drilling, we make it easy for you and your customers to get exactly what's needed.

PICTURED L to R: CEO Debra Behring, President Jason Greenwood, EVP William Filthaut, JR.

CONTENTS

02

Ordering Info

05

3D Laminate
Benchmark Collection

26

3D Laminate Frame And
Mullion Doors

27

3D Laminate Panels &
Multi Panels

28

3D Laminate Specialty

30

Shelves

31

Moulding
Trim & Toekicks

33

Surfaces

35

5 Piece Craftsman Series

42

Inserts

45

5 Piece Artisan

PRODUCT GUIDE

Customer Service Contact Info

Hours: M-F, 8am to 4:30pm EST

PH: 586.468.4765

FX: 586.468.4861

Orders: doororders@jbcutting.com

Support: support@jbcutting.com

Placing an Order

Orders can be faxed, emailed, or placed via our online order portal 24 hours a day. Phone orders are not accepted. Order forms are available for download at www.jbcutting.com/resources.

- Portal orders are placed in inches
- Order forms will accept inches or millimeters
- All sizes are width x height
- All pricing is per sq foot except where noted
- 1.5 sq. ft. per piece charge applies on all products
- \$75 minimum order charge applies prior to freight, packaging and other fees

Incomplete orders or orders with questions will be placed on hold until the correct information is received.

Lead Times

Lead times vary by type of product and finish. Generally, orders ship within seven to ten business days. The ship day on the confirmation is the day your product leaves the factory. Transit time depends on location.

Order Confirmations

All orders are confirmed within 24 hours. Contact support if you do not receive a confirmation.

Changes or Cancellations

- Changes or cancellations must be received in writing.
- Any changes affecting parts in process may be charged at 50% depending on how far along the parts are in production.

Rush Orders

Rush orders are available subject to approval.

- Orders up to \$250 (prior to shipping fees) are \$125.
- Orders \$251 - \$1000 (prior to shipping fees) are billed at 50% of the order total.
- Orders above \$1000 are available on a case by case basis. Contact support for details.
- Rush orders cannot be canceled or changed.

Packaging

JBC packaging has been approved by all major parcel and LTL carriers. Standard packaging is included in published pricing. Discounts do not apply to packaging or freight charges.

Shipping and Delivery

Orders will ship via small package (parcel) or LTL depending on size. Transit times are the best estimate.

Damage/Defects/Missing Product

Please report all damages/defects/missing products within 10 days of receipt to support@jbcutting.com. JBC requires 3 items for replacement of product:

- Photo of defect/damage
- Photo of part label
- Date replacement needed

HOW TO ORDER

Drilling

JBC offers three standard hole patterns for hinge boring:

00

Cup Hole Only

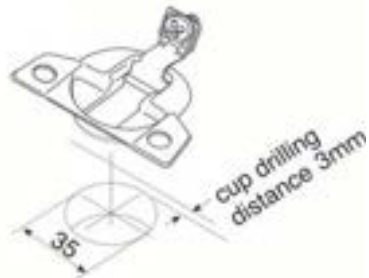

01

8mm dowels
42mm apart

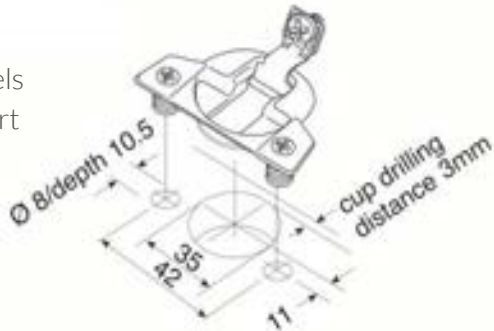

02

8mm dowels
45mm apart

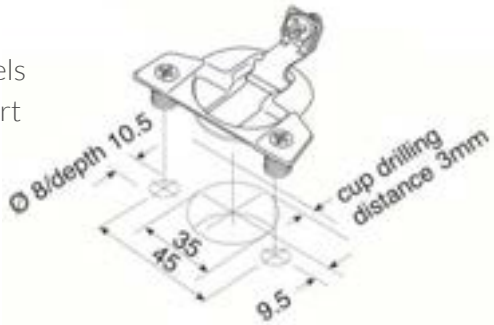

Unless otherwise specified, hinge cup drilling will be 12mm deep.

Customer must add a prefix to the drilling pattern depending upon door shape and how many holes per door.

eg. "SQ201" would denote a square inside profile (not arch or cathedral), hinge pattern 01 with 2 holes per door. Arch or Cathedral begin with UN (uneven) and must be ordered as lefts or rights.

JBC Standard Hinge Placement

- Doors up to 39.99" - 2 holes
- Doors 40" to 62.99" - 3 holes
- Doors 63" to 78.75" - 4 holes
- Doors 78.76" and above - 5 holes

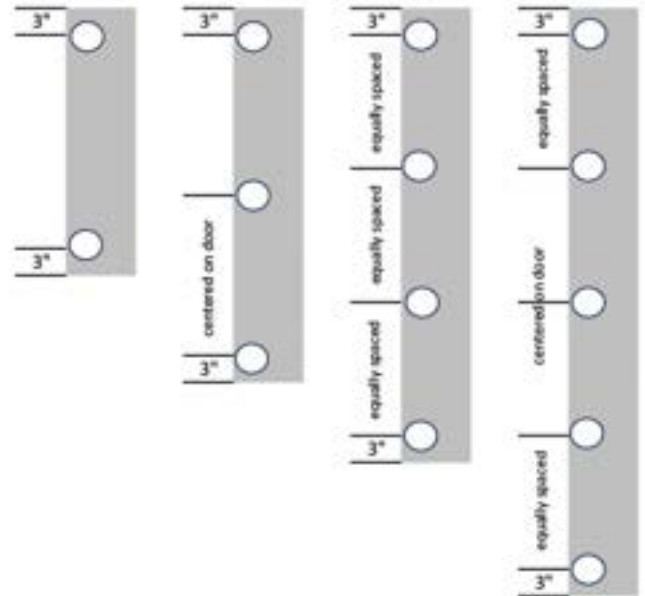

Edge Distance

- Unless otherwise specified, the cup hole begins 3mm from the edge of the door.
- Unless otherwise specified, the cup hole will be 3" on center from the top and bottom of the door.

Drawer Front Drilling

Drawer front drilling is available, please contact customer service for more information.

Custom Drilling

Complete custom drilling is available. Please contact customer service to help set up your custom solution.

BENCHMARK



**Material | 3DL
(Thermofoil)**

**Profiles | Contemporary,
Standard, Applied
Molding and Shakers**

Machined out of a 5x8 sheet of 1-sided MDF. Water-based glue is applied & any of our 3DL finishes are membrane pressed onto the components.

What is 3DL?

3DL or Three Dimensional Laminate is made from PVC. It is also known as thermofoil. It is a thin plastic veneer that when heated, will form to routed, MDF core components.

What is the core made out of?

JBC uses double refined MDF from North American mills with one side laminated in a matching or complimentary TFL (melamine). This substrate is 100% recycled, and among the most green products on the market.

How are parts made?

Parts are machined out of 3/4" or 5/8" thick one sided MDF. A profile is routed into the core, the parts advance through a robotic glue spraying machine, and then 3DL is membrane pressed on to the fronts of the parts.

Cleaning and Care

Clean with a mild detergent and soft microfiber cloth. Solvent based cleansers will mar or damage the PVC and should not be used. Acetone or Lacquer thinner should never be used to clean 3DL.

Finishes

Our 3DL palette includes solids, super mattes, textured woodgrains, high glosses and abstracts. Some of these finishes come with a protective covering (peel coat). The covering should be removed promptly after installation but before adding decorative hardware. Do not expose parts to sunlight or slide parts across rough surfaces. Our 3DL finish palette is viewable here:

www.jbcutting.com/swatches

Warranty

JBC guarantees all 3DL components for a period of five years. This guarantee is limited to raw materials or manufacturing defects only. Normal wear, improper installations, misuse are excluded from this warranty. JBC to replace product only. Labor, transportation or inconvenience charges are excluded.

How to order

Customers may order through the JBC order portal or via order form.

Customers may specify parts by name or by part code (see following pages).

1 "B" CODE | DENOTES STYLE

for example, square/arch/cathedral

2 "N" CODE | DENOTES INSIDE PROFILE

3 "S" CODE | DENOTES OUTSIDE PROFILE

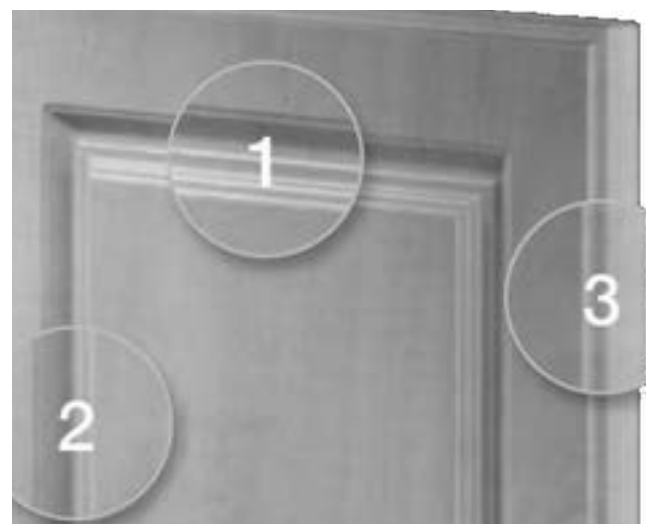

Drawer Fronts

Drawer fronts have reduced rails as standard, see following pages for options for equal rails and/or slab fronts.

3 D L

PROFILES & SPECIFICATIONS

N000 | Slab



*Door grain runs in the height and drawer grain runs in the width

Styles Available (B Code)

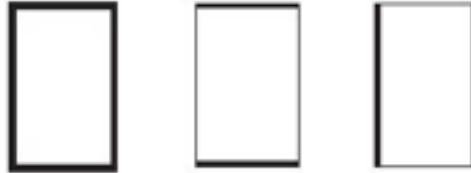

B100 Flat door, outside profile applied to all edges

B130 Flat door, outside profile applied to top & bottom edges, left & right edges are square

B131 Flat door, outside profile applied to left & right edges, top & bottom edges are square

Inside Profile (N Code)

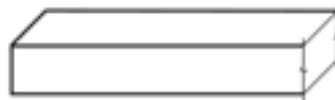

N000 No profile, door is flat

Outside Profiles Available (S Code)

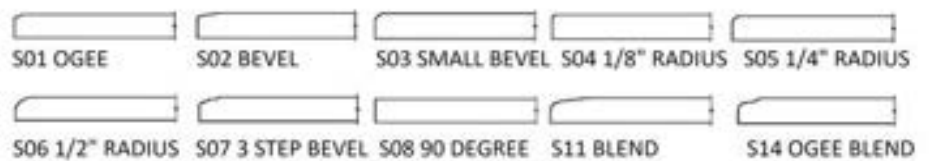

Options

Frame/
Mullion

- See page 26 for Styles (B Codes)
- See page 42-43 for Inserts (Glass/Leather/Mesh)
- Available as frame only - gasket material provided
- JBC converts inside profile to N004 to match N000
- 2-1/4" stiles and rails standard

Sizing

- Minimum Size (Doors): 3" x 5"
- Maximum Size (Doors): 46" x 94"
- Minimum Size (Dwrs): 5" x 3"
- Maximum Size (Dwrs): 94" x 46"
- Equal Rails: N/A
- Reduced Rails: N/A

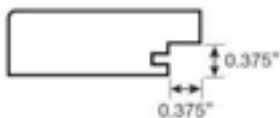

N000 | Columbia



*Door grain runs in the height and drawer grain runs in the width

Styles Available (B Code)



B100 Flat door, outside profile applied to all edges

Inside Profile (N Code)



N000 No profile, door is flat

Outside Profiles Available (S Code)



Options



Frame/
Mullion

- See page 26 for Styles (B Codes)
- See page 42-43 for Inserts (Glass/Leather/Mesh)
- Available as frame only - gasket material provided
- JBC converts inside profile to N004 to match N000
- 2-1/4" stiles and rails standard

Sizing

- Minimum Size (Doors): 3" x 5"
- Maximum Size (Doors): 46" x 94"
- Minimum Size (Dwrs): 5" x 3"
- Maximum Size (Dwrs): 94" x 46"
- Equal Rails: N/A
- Reduced Rails: N/A

3 D L

PROFILES & SPECIFICATIONS

N000 | Manhattan



*Door grain runs in the height and drawer grain runs in the width

Styles Available (B Code)



B100 Flat door, outside profile applied to all edges

Inside Profile (N Code)

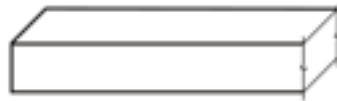

N000 No profile, door is flat

Outside Profiles Available (S Code)

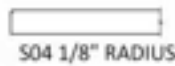

Options

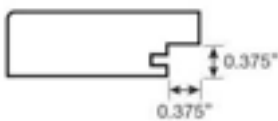

Frame/
Mullion

- See page 26 for Styles (B Codes)
- See page 42-43 for Inserts (Glass/Leather/Mesh)
- Available as frame only - gasket material provided
- JBC converts inside profile to N004 to match N000
- 2-1/4" stiles and rails standard

Sizing

- Minimum Size (Doors): 3" x 5"
- Maximum Size (Doors): 46" x 94"
- Minimum Size (Dwrs): 5" x 3"
- Maximum Size (Dwrs): 94" x 46"
- Equal Rails: N/A
- Reduced Rails: N/A

N200 | Delaware



*Door grain runs in the height and drawer grain runs in the width

Styles Available (B Code)

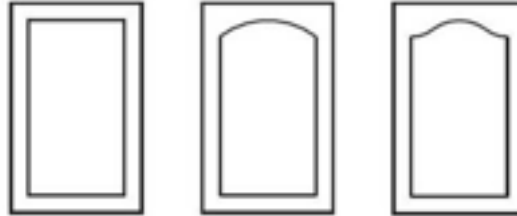

B200 Square

B300 Arch

B400 Cathedral

Inside Profile (N Code)



N200 Traditional raised panel with round corners, 2.4" stiles & rails

Outside Profiles Available (S Code)



Options

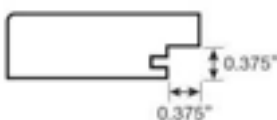

Frame/
Mullion

- See page 26 for Styles (B Codes)
- See page 42-43 for Inserts (Glass/Leather/Mesh)
- Available as frame only - gasket material provided
- JBC converts inside profile to N001 to match N200
- 2.4" stiles and rails standard

Sizing

- Minimum Size (Doors): 8-1/16" x 8-1/16"
- Maximum Size (Doors): 46" x 94"
- Minimum Size (Dwrs): 8-1/16" x 5-1/2"
- Maximum Size (Dwrs): 94" x 46"
- Dwr rails will be reduced unless otherwise specified, equal rails available if dwr is over 8-1/16" x 8-1/16" minimum

3 D L

PROFILES & SPECIFICATIONS

N300 | Chesapeake



*Door grain runs in the height and drawer grain runs in the width

Styles Available (B Code)

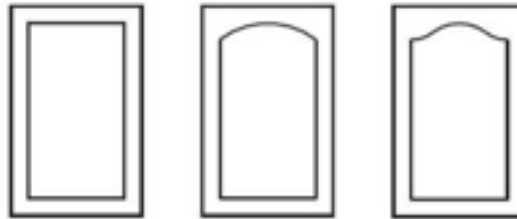

B200 Square

B300 Arch

B400 Cathedral

Inside Profile (N Code)



N300 Traditional raised panel with square corners, 2-1/4" stiles & rails

Outside Profiles Available (S Code)



Options

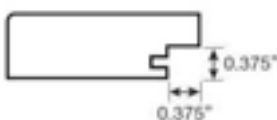

Frame/
Mullion

- See page 26 for Styles (B Codes)
- See page 42-43 for Inserts (Glass/Leather/Mesh)
- Available as frame only - gasket material provided
- JBC converts inside profile to N002 to match N300
- 2-1/4" stiles and rails standard

Sizing

- Minimum Size (Doors): 8-1/8" x 8-1/8"
- Maximum Size (Doors): 46" x 94"
- Minimum Size (Dwrs): 8-1/8" x 5-7/8"
- Maximum Size (Dwrs): 94" x 46"
- Dwr rails will be reduced unless otherwise specified, equal rails available if dwr is over 8-1/8" x 8-1/8" minimum

N301 | Lakeshore



*Door grain runs in the height and drawer grain runs in the width

Styles Available (B Code)



B200 Square

B300 Arch

B400 Cathedral

Inside Profile (N Code)



N301 Traditional raised panel with square corners, 2-1/4" stiles & rails

Outside Profiles Available (S Code)



Options

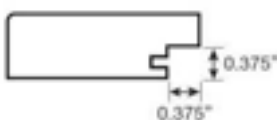

Frame/
Mullion

- See page 26 for Styles (B Codes)
- See page 42-43 for Inserts (Glass/Leather/Mesh)
- Available as frame only - gasket material provided
- JBC converts inside profile to N002 to match N301
- 2-1/4" stiles and rails standard

Sizing

- Minimum Size (Doors): 8-1/8" x 8-1/8"
- Maximum Size (Doors): 46" x 94"
- Minimum Size (Dwrs): 8-1/8" x 5-7/8"
- Maximum Size (Dwrs): 94" x 46"
- Dwr rails will be reduced unless otherwise specified, equal rails available if dwr is over 8-1/8" x 8-1/8" minimum

3 D L

PROFILES & SPECIFICATIONS

N400 | Northwest



*Door grain runs in the height and drawer grain runs in the width

Styles Available (B Code)

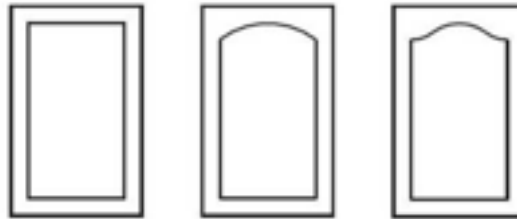

B200 Square

B300 Arch

B400 Cathedral

Inside Profile (N Code)



N400 Traditional raised panel with square corners, 2" stiles & rails

Outside Profiles Available (S Code)



Options

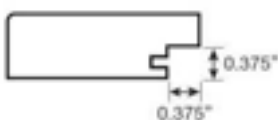

Frame/
Mullion

- See page 26 for Styles (B Codes)
- See page 42-43 for Inserts (Glass/Leather/Mesh)
- Available as frame only - gasket material provided
- JBC converts inside profile to N003 to match N400
- 2" stiles and rails standard

Sizing

- Minimum Size (Doors): 7" x 7"
- Maximum Size (Doors): 46" x 94"
- Minimum Size (Dwrs): 7" x 4-3/4"
- Maximum Size (Dwrs): 94" x 46"
- Dwr rails will be reduced unless otherwise specified, equal rails available if dwr is over 7" x 7" minimum

N401 | Sonoma



*Door grain runs in the height and drawer grain runs in the width

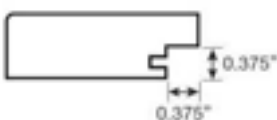

Styles Available (B Code)

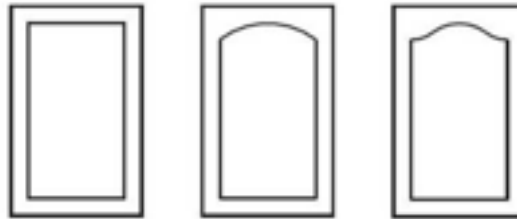

B200 Square

B300 Arch

B400 Cathedral

Inside Profile (N Code)



N401 Traditional raised panel with square corners, 2-1/4" stiles & rails

Outside Profiles Available (S Code)



Options

Frame/
Mullion

- See page 26 for Styles (B Codes)
- See page 42-43 for Inserts (Glass/Leather/Mesh)
- Available as frame only - gasket material provided
- JBC converts inside profile to N003 to match N401
- 2-1/4" stiles and rails standard

Sizing

- Minimum Size (Doors): 7-1/2" x 7-1/2"
- Maximum Size (Doors): 46" x 94"
- Minimum Size (Dwrs): 7-1/2" x 4-3/4"
- Maximum Size (Dwrs): 94" x 46"
- Dwr rails will be reduced unless otherwise specified, equal rails available if dwr is over 7-1/2" x 7-1/2" minimum

3 D L

PROFILES & SPECIFICATIONS

N500 | Sierra



*Door grain runs in the height and drawer grain runs in the width

Styles Available (B Code)

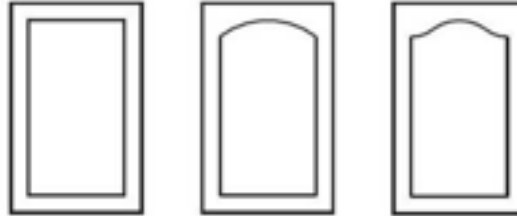

B200 Square

B300 Arch

B400 Cathedral

Inside Profile (N Code)



N500 Raised panel with slightly rounded corners, 2-1/4" stiles & rails

Outside Profiles Available (S Code)



Options

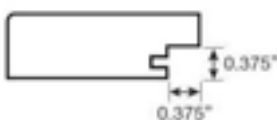

Frame/
Mullion

- See page 26 for Styles (B Codes)
- See page 42-43 for Inserts (Glass/Leather/Mesh)
- Available as frame only - gasket material provided
- JBC converts inside profile to N005 to match N500
- 2-1/4" stiles and rails standard

Sizing

- Minimum Size (Doors): 8-1/4" x 8-1/4"
- Maximum Size (Doors): 46" x 94"
- Minimum Size (Dwrs): 8-1/4" x 6"
- Maximum Size (Dwrs): 94" x 46"
- Dwr rails will be reduced unless otherwise specified, equal rails available if dwr is over 8-1/4" x 8-1/4" minimum

N507 | Catalina



*Door grain runs in the height and drawer grain runs in the width

Styles Available (B Code)

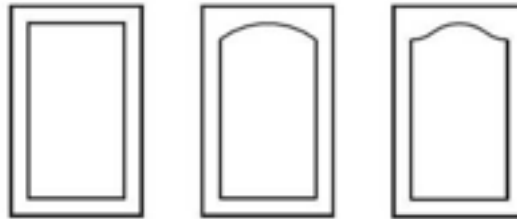

B200 Square

B300 Arch

B400 Cathedral

Inside Profile (N Code)



N507 Traditional raised panel with square corners, 2-1/4" stiles & rails

Outside Profiles Available (S Code)



Options

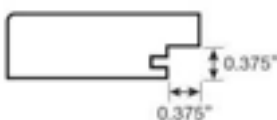

Frame/
Mullion

- See page 26 for Styles (B Codes)
- See page 42-43 for Inserts (Glass/Leather/Mesh)
- Available as frame only - gasket material provided
- JBC converts inside profile to N003 to match N507
- 2-1/4" stiles and rails standard

Sizing

- Minimum Size (Doors): 8-1/4" x 8-1/4"
- Maximum Size (Doors): 46" x 94"
- Minimum Size (Dwrs): 8-1/4" x 6"
- Maximum Size (Dwrs): 94" x 46"
- Dwr rails will be reduced unless otherwise specified, equal rails available if dwr is over 8-1/4" x 8-1/4" minimum

3 D L

PROFILES & SPECIFICATIONS

N115 | Great Plains

Styles Available (B Code)



B600 Shaker

Inside Profile (N Code)



N115 Transitional shaker with 3" stile and rail

*Door grain runs in the height and drawer grain runs in the width

Outside Profiles Available (S Code)

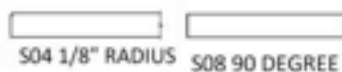

Options

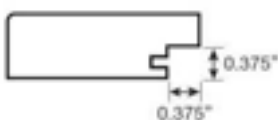

Frame/
Mullion

- See page 26 for Styles (B Codes)
- See page 42-43 for Inserts (Glass/Leather/Mesh)
- Available as frame only - gasket material provided
- JBC converts inside profile to N006 to match N115
- 3" stiles and rails standard
- Available with 2.25" stiles & rails as "Northern Plains"

Sizing

- Minimum Size (Doors): 7-7/8" x 7-7/8"
- Maximum Size (Doors): 46" x 94"
- Minimum Size (Dwrs): 7-7/8" x 6-1/4"
- Maximum Size (Dwrs): 94" x 46"
- Dwr rails not available as reduced (3"), equal rails only or slab
- Northern Plains dwrs available with reduced rails

N100 | Kodiak



*Door grain runs in the height and drawer grain runs in the width

Styles Available (B Code)



B600 Shaker

Inside Profile (N Code)

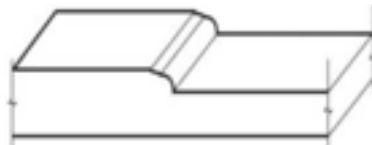

N100 Traditional shaker with 2-1/4" stile and rail

Outside Profiles Available (S Code)

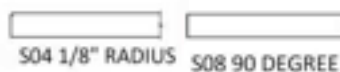

Options

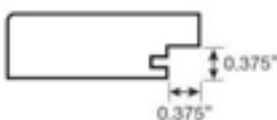

Frame/
Mullion

- See page 26 for Styles (B Codes)
- See page 42-43 for Inserts (Glass/Leather/Mesh)
- Available as frame only - gasket material provided
- JBC converts inside profile to N005 to match N100
- 2-1/4" stiles and rails standard

Sizing

- Minimum Size (Doors): 7-1/2" x 7-1/2"
- Maximum Size (Doors): 46" x 94"
- Minimum Size (Dwrs): 7-1/2" x 5-1/2"
- Maximum Size (Dwrs): 94" x 46"
- Dwr rails will be reduced unless otherwise specified, equal rails available if dwr is over 7-1/2" x 7-1/2" minimum

3 D L

PROFILES & SPECIFICATIONS

N101 | Shasta



*Door grain runs in the height and drawer grain runs in the width

Styles Available (B Code)



B600 Shaker

Inside Profile (N Code)



N101 Traditional shaker with 2-1/4" stile and rail

Outside Profiles Available (S Code)

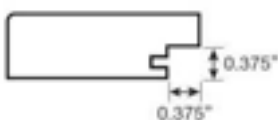
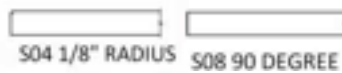

Options

<p>Frame/ Mullion</p>	<ul style="list-style-type: none"> •See page 26 for Styles (B Codes) •See page 42-43 for Inserts (Glass/Leather/Mesh) •Available as frame only - gasket material provided •JBC converts inside profile to N002 to match N101 •2-1/4" stiles and rails standard
<p>Sizing</p>	<ul style="list-style-type: none"> •Minimum Size (Doors): 7-1/2" x 7-1/2" •Maximum Size (Doors): 46" x 94" •Minimum Size (Dwrs): 7-1/2" x 5-1/2" •Maximum Size (Dwrs): 94" x 46" •Dwr rails will be reduced unless otherwise specified, equal rails available if dwr is over 7-1/2" x 7-1/2" minimum

N117 | Coronado



*Door grain runs in the height and drawer grain runs in the width

Styles Available (B Code)



B600 Shaker

Inside Profile (N Code)

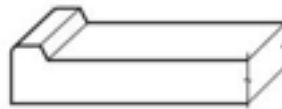

N117 Modern slim shaker with 1/2" stiles and rails

Outside Profiles Available (S Code)



Options

Frame/ Mullion	<ul style="list-style-type: none"> •Not available with 1/2" stiles and rails see Shasta for 2.25" option
Sizing	<ul style="list-style-type: none"> •Minimum Size (Doors): 7" x 7" •Maximum Size (Doors): 46" x 94" •Minimum Size (Dwrs): 2" x 2" •Maximum Size (Dwrs): 94" x 46" •Dwr rails will be 1/2" on all sides (same as doors)

3 D L

PROFILES & SPECIFICATIONS

N102 | Forsyth



*Door grain runs in the height and drawer grain runs in the width

Styles Available (B Code)



B602 Shaker

Inside Profile (N Code)



N102 Traditional beaded panel shaker with 2-1/4" stile and rail

Outside Profiles Available (S Code)

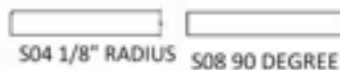

Options

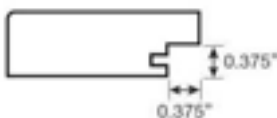

Frame/
Mullion

- See page 26 for Styles (B Codes)
- See page 42-43 for Inserts (Glass/Leather/Mesh)
- Available as frame only - gasket material provided
- JBC converts inside profile to N004 to match N102
- 2-1/4" stiles and rails standard

Sizing

- Minimum Size (Doors): 7-1/2" x 7-1/2"
- Maximum Size (Doors): 46" x 94"
- Minimum Size (Dwrs): 7-1/2" x 5-1/2"
- Maximum Size (Dwrs): 94" x 46"
- Dwr rails will be reduced unless otherwise specified, equal rails available if dwr is over 8-1/16" x 8-1/16" minimum

N161 | French Quarter

Styles Available (B Code)



B602 Shaker

Inside Profile (N Code)



N161 Elevated traditional shaker with 2-1/4" stile and rail

*Door grain runs in the height and drawer grain runs in the width

Outside Profiles Available (S Code)

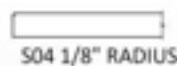

Options

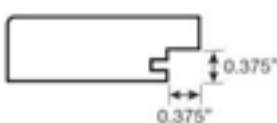

Frame/
Mullion

- See page 26 for Styles (B Codes)
- See page 42-43 for Inserts (Glass/Leather/Mesh)
- Available as frame only - gasket material provided
- JBC converts inside profile to N006 to match N161
- 2-1/4" stiles and rails standard

Sizing

- Minimum Size (Doors): 6-3/4" x 6-3/4"
- Maximum Size (Doors): 46" x 94"
- Minimum Size (Dwrs): 6-3/4" x 6-3/4"
- Maximum Size (Dwrs): 94" x 46"
- Dwr rails not available as reduced, equal rails only or slab

3 D L

PROFILES & SPECIFICATIONS

N103 | Atlantic



*Door grain runs in the height and drawer grain runs in the width

Styles Available (B Code)



B640 Shaker

Inside Profile (N Code)



N103 5 piece look traditional shaker with 2-1/4" stile and rail

Outside Profiles Available (S Code)



Options

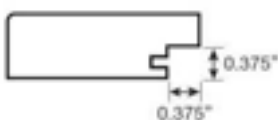

Frame/
Mullion

- See page 26 for Styles (B Codes)
- See page 42-43 for Inserts (Glass/Leather/Mesh)
- Available as frame only - gasket material provided
- JBC converts inside profile to N002 to match N103
- 2-1/4" stiles and rails standard

Sizing

- Minimum Size (Doors): 7-1/2" x 7-1/12"
- Maximum Size (Doors): 46" x 94"
- Minimum Size (Dwrs): 7-1/2" x 5-1/2"
- Maximum Size (Dwrs): 94" x 46"
- Dwr rails will be reduced unless otherwise specified, equal rails available if dwr is over 7-1/2" x 7-1/2" minimum

N701 | Hudson



*Door grain runs in the height and drawer grain runs in the width

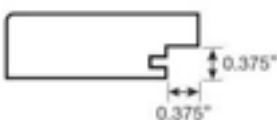

Styles Available (B Code)



B600 True square corner

Inside Profile (N Code)



N701 True square corner with 2" stile and rail

Outside Profiles Available (S Code)



Options

Frame/ Mullion	<ul style="list-style-type: none"> • See page 26 for Styles (B Codes) • See page 42-43 for Inserts (Glass/Leather/Mesh) • Available as frame only - gasket material provided • JBC converts inside profile to N003 to match N701 • 2" stiles and rails standard
Sizing	<ul style="list-style-type: none"> • Minimum Size (Doors): 8-1/4" x 8-1/4" • Maximum Size (Doors): 46" x 94" • Minimum Size (Dwrs): 8-1/4" x 6-1/8" • Maximum Size (Dwrs): 94" x 46" • Dwr rails will be reduced unless otherwise specified, equal rails available if dwr is over 8-1/4" x 8-1/4" minimum

3 D L

PROFILES & SPECIFICATIONS

N702 | Pacific



*Door grain runs in the height and drawer grain runs in the width

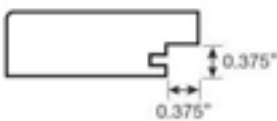

Styles Available (B Code)



B600 Applied Molding

Inside Profile (N Code)



N702 Applied molding with 2" stile and rail

Outside Profiles Available (S Code)



Options

Frame/ Mullion	<ul style="list-style-type: none"> •See page 21 for Styles (B Codes) •See page 22 for Inserts (Glass/Leather/Mesh) •Available as frame only - gasket material provided •JBC converts inside profile to N006 to match N702 •2" stiles and rails standard
Sizing	<ul style="list-style-type: none"> •Minimum Size (Doors): 7-1/2" x 7-1/2" •Maximum Size (Doors): 46" x 94" •Minimum Size (Dwrs): 7-1/2" x 5-3/8" •Maximum Size (Dwrs): 94" x 46" •Dwr rails will be reduced unless otherwise specified, equal rails available if dwr is over 7-1/2" x 7-1/2" minimum

N706 | New England

Styles Available (B Code)



B600 Applied Molding

Inside Profile (N Code)

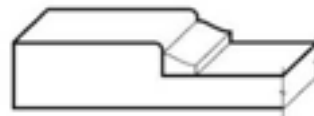

N706 Applied molding with 2-1/4" stile and rail

*Door grain runs in the height and drawer grain runs in the width

Outside Profiles Available (S Code)



Options

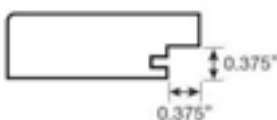

Frame/ Mullion	<ul style="list-style-type: none"> •See page 26 for Styles (B Codes) •See page 42-43 for Inserts (Glass/Leather/Mesh) •Available as frame only - gasket material provided •JBC converts inside profile to N006 to match N706 •2-1/4" stiles and rails standard
Sizing	<ul style="list-style-type: none"> •Minimum Size (Doors): 7-1/8" x 7-1/8" •Maximum Size (Doors): 46" x 94" •Minimum Size (Dwrs): 5" x 3" •Maximum Size (Dwrs): 94" x 46" •Dwrs available as slab only

3DL

FRAME & MULLION DOORS

Styles Available (B Code)



B201
Minimum
8-13/16" x 8-13/16"

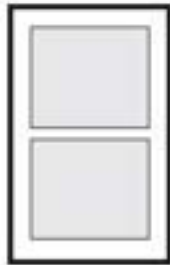

B202
Minimum
8-13/16" x 13-13/16"

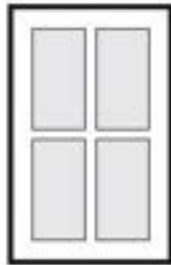

B204
Minimum
13-13/16" x 13-13/16"



B206
Minimum
13-13/16" x 18-13/16"



B208
Minimum
13-13/16" x 22-13/16"



B301
Minimum
8-13/16" x 8-13/16"



B302
Minimum
8-13/16" x 8-13/16"

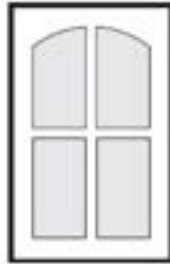

B304
Minimum
12" x 14-13/16"



B306
Minimum
12" x 18-13/16"



B308
Minimum
13-13/16" x 22-13/16"



B401
Minimum
8-13/16" x 8-13/16"



B402
Minimum
8-13/16" x 8-13/16"



B404
Minimum
13" x 14-13/16"



B406
Minimum
13" x 18-13/16"



B408
Minimum
13" x 22-13/16"



B641
Minimum
7-1/2" x 7-1/2"

- B641 mimics a 5PC look door
- Use with N103 (Atlantic) only



Adhesive-type installation

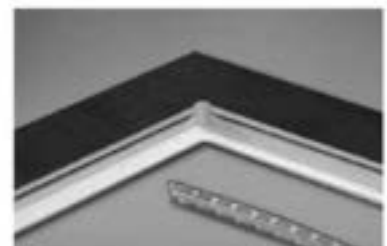

Gasket-type installation

Multiple Panels & Island Backs

Multiple and variable panels can be produced to accommodate many designs. Panels Can be horizontal or vertical but are limited to 45" wide and 94" long. For longer length, consider designing with multiple sections.



B220

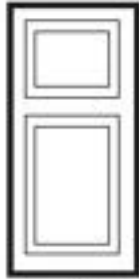

B221*

- B221 is variable
- Please provide drawing

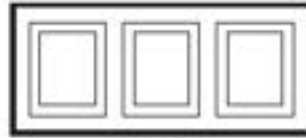

B222



B225*

- B225 is variable
- Please provide drawing

Appliance Panels & Frames

Appliance panels are available to match the cabinet doors as a finished look. We offer a 3/4" matching profile attached to a piece of 1/4" material. Check the manufacturer's manual for dimensions

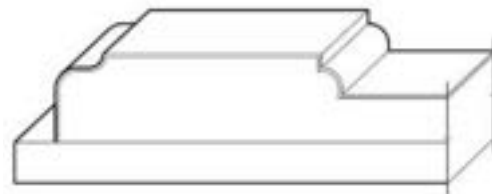

Appliance frames can be produced with matching foil. Specify rail sizes and opening dimensions. Inside cutouts will be left raw.

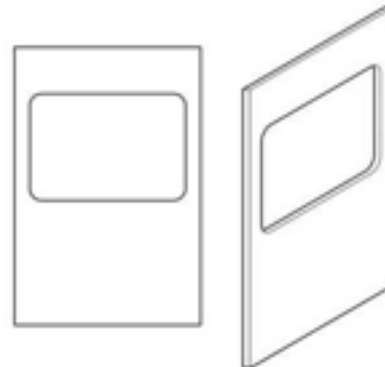

Finished End Panels

Doors are typically used as a finished end. However, they can be customized if you desire. Slab panels can be pressed in the same finish as the doors using 1/4" or 1" thicknesses (the backside will be raw or white melamine). Panels can also be miter folded to achieve a thicker than 1" look.

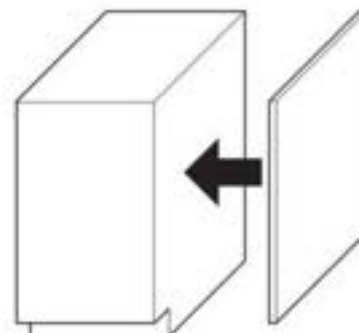

3 D L

SPECIALTY

Hood Vents

Door panels can be produced to cover hood vents. Specific drawings are required. **Some profiles will not work with the angle designs and will need to be square. Contact support for options available.

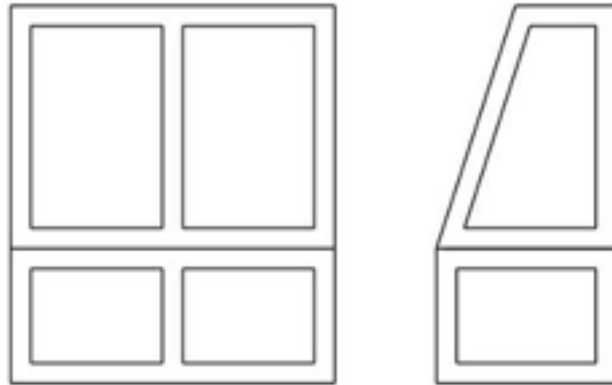

Island Legs & Decorative Offsets

Miter folding can be used to produce island legs or other decorative pieces. Parts can be fabricated as square or with an offset. Specific dimensions are required.

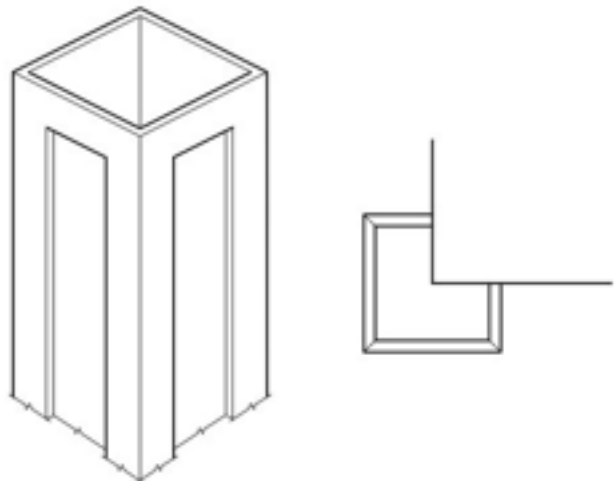

Lazy Susan

Doors can be produced with offset rails to accommodate corner cabinets or lazy susans. If your design calls for two doors to attach in a corner, specify which door needs to have an increased rail to accommodate the 3/4" door attaching to it.

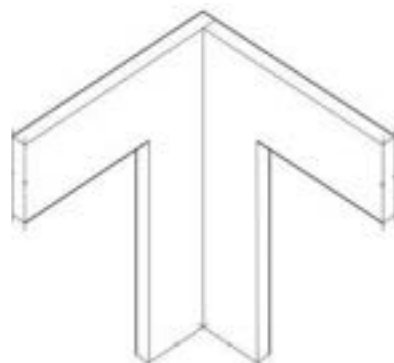

Valances

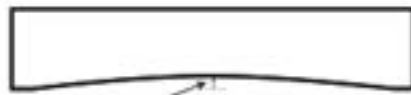

B028
Single Arch Valance



B029
Double Arch Valance

When ordering, specify outside edge detail and chord height.

Fluted Fillers



B160

3" wide to 94" in length

4" wide to 94" in length

Also available in custom sizes

Note: rosettes can be ordered individually – 3" x 3"

All flutes start and stop 2" from each end and are 3/4" on center.

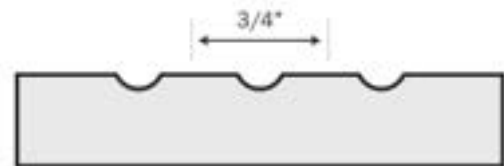

Wine Racks



18" long – space for 4 bottles

24" long – space for 6 bottles

30" long – space for 7 bottles

Please order by set (set = 2 pieces) or each.

Custom sizes available, please specify length or drawing.

JB Cutting can tailor custom products to meet your exact specifications. We are continuously striving to bring new and innovative products to our customers. We welcome your requests for quotations on custom store fixtures, health care furniture or point of purchase displays.

3 D L

SHELVES

Floating Shelves

Floating shelves are 2-5/16" tall, 10" wide and come in 18", 24", 36", and 48" lengths. Custom sizes are available upon request. Brackets can be provided at an additional charge.

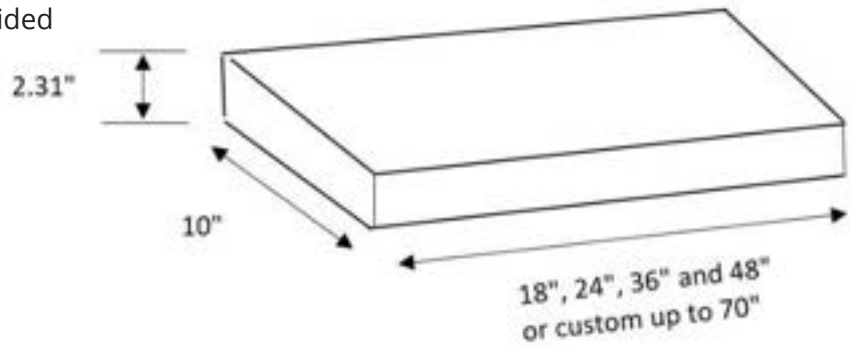

Robust Shelves

Robust shelves are 3/4" thick shelves with a 2" miter folded lip. These shelves can be customized as needed. Face and edges will be a matching 3DL, the underside will be melamine, either matching or complimentary.

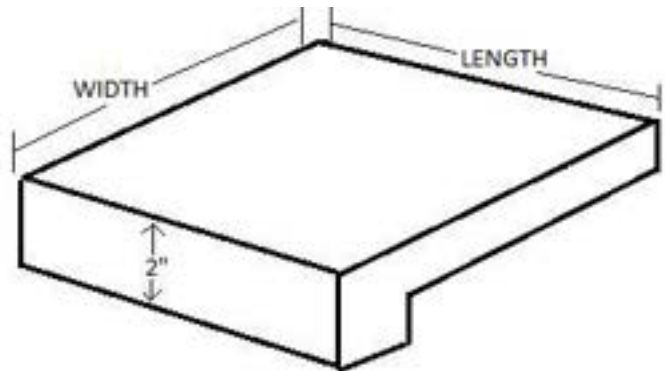

Exposed Shelves

Parts can be produced as corner shelves or exposed open cabinets. Face and edges will be matching 3DL, the underside will be a matching melamine.

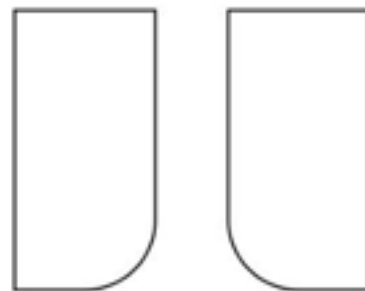

Crown Moulding

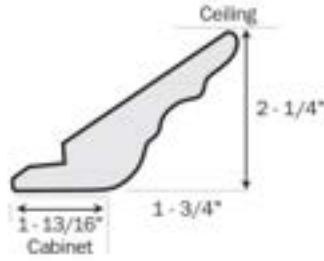

A112
Top Mount

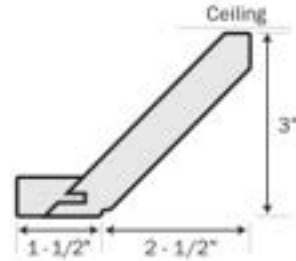

A130
Top Mount

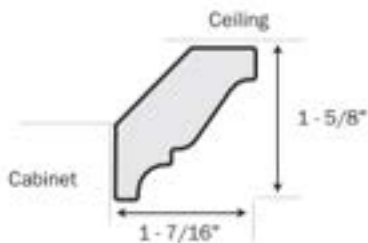

A102
Face Mount

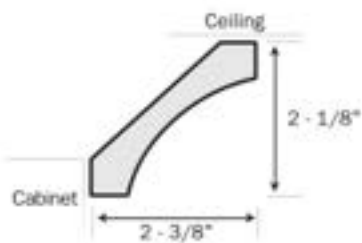

A114
Face Mount

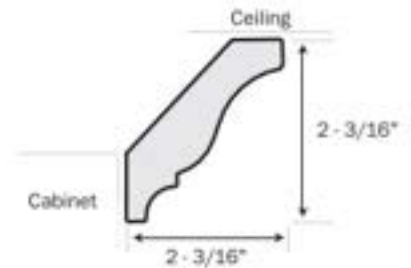

A101
Face Mount

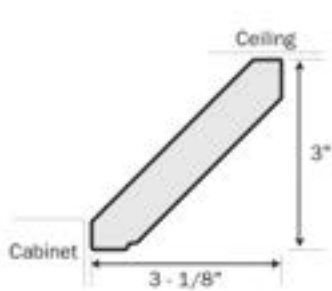

A140
Face Mount

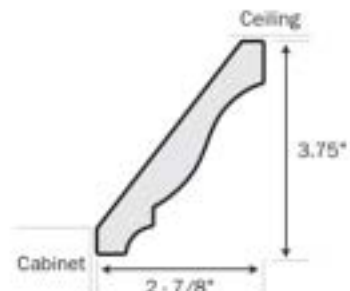

A141
Face Mount

ATTENTION:

Drawings contained on these pages are not to scale. They are for reference only.
Contact us at 586.468.4765 for samples of actual products.

3 D L

MOULDING

Trim Moulding

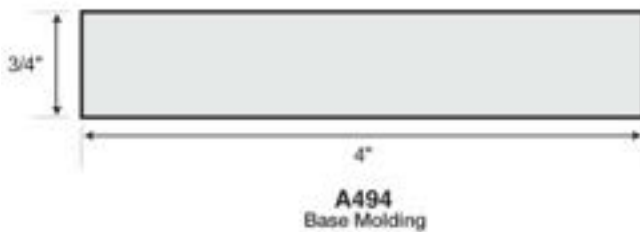
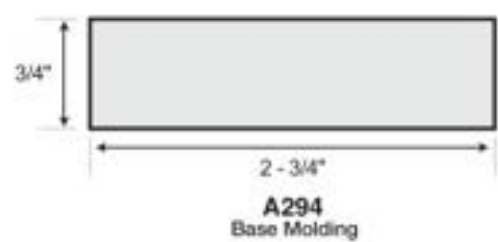
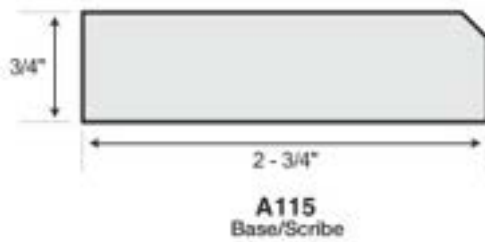
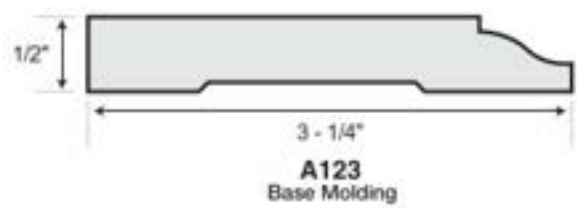
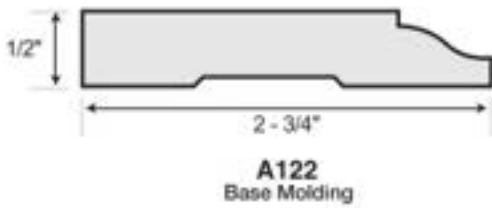
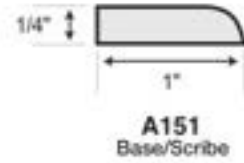
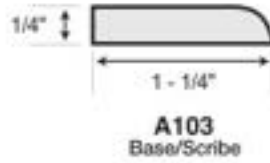

Toe Kick Material

Toe kicks can be produced as cut to size in 1/4" and 3/4" material, edges are raw or as a fully finished piece covering the face and edges.

*see detail of drawing

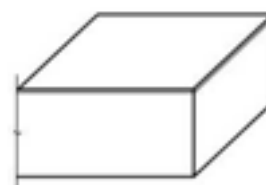

Unfinished Edge

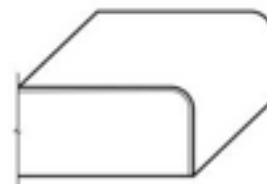

Finished Edge

Surfaces



Searching for surfaces? We've got you covered.

JBC surfaces are durable, seamless and affordable. With no need for edge banding, they're perfect for closets, office desktops, store fixtures and head boards or foot boards. Your creations can be ordered in various shapes and finish combinations.

- Available in 3/4" or 1" thickness with a white or black back.
- Available in all 3DL finishes
- Outside corners will have an 1/8" radius unless otherwise specified.

Profiles Available

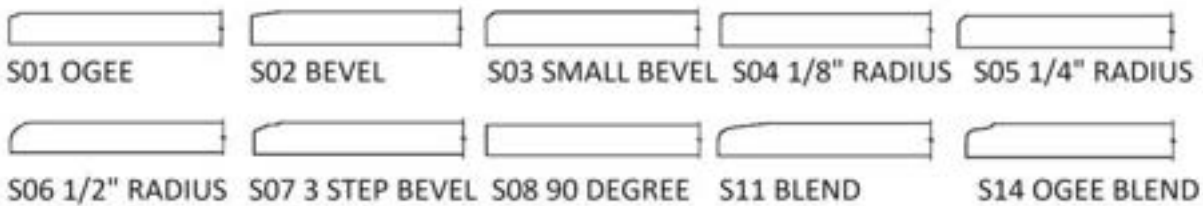

Standard Shapes

*Bold line denotes decorative profile edge - see above selections



JBCREC-BOT



JBCREC-TB



JBCREC-LB



JBCREC-BR



JBCREC-ALL4



JBCREC-TLB



JBCREC-TRB



JBCREC-LBR



JBCNOTCH

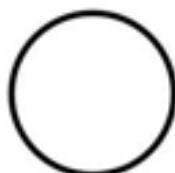

JBCROUND



JBCURVE-LEFT



JBCURVE-RIGHT

CRAFTSMAN



**Material | DLV
(Decorative Laminate
Veneer)**

**Profiles | Shaker,
Transitional, and
Variations**
Profile wrapped,
grooved door moldings
are assembled around
a 1/4" thick matching
center panel.

What are 5 Piece Fronts?

5PC fronts consist of saturated melamine paper which is profile wrapped around door moldings which are assembled through mortise and tenon construction around a 1/4" thick matching center panel. The grain direction on the stiles and rails makes for a realistic appearance.

Cleaning and Care

Clean with a mild detergent and soft microfiber cloth. Solvent based cleansers should not be used. Acetone or Lacquer thinner should never be used to clean 5PC.

Frames

Frame only doors are available in the 5PC product line. Mullion (cross pieces) are not available. Best practice is to allow JBC to install the insert at the factory. Customer sourced glass installation will void the warranty.

Back of door with glass installed and fully encapsulated



Back of door without glass installed, frame only



Warranty

JBC guarantees all 5PC components for a period of five years. This guarantee is limited to raw materials or manufacturing defects only. Normal wear, improper installations, misuse are excluded from this warranty. JBC to replace product only. Labor, transportation or inconvenience charges are excluded.

How to order

Customers may order through the JBC order portal or via order form.

Customers may specify parts by name or by part code (see following pages).

Drawer Fronts

Drawer fronts will not have reduced rails as standard, see following pages for minimums.

Accessories

See 3DL sections, many of the 5pc finishes have matching 3DL's to aid in giving your projects a fully finished look.

Multiple Panels

Multiple panels are not available in the 5pc product line.

Grain Direction

Vertical grain is standard on door insert panels. Horizontal grain is standard on drawer insert panels. Grain can be manipulated, contact support when placing your order.

5 P C

PROFILES & SPECIFICATIONS

Milan



Finishes

After Hours	Aliso	Alno	Antique White	Apres Ski
Black	Casting @ 1st Lt	Celadon	Equinox	Mysterious
Nizza	River Rock	Sarek Ash	Summer Breeze	Vintage
Weekend Getaway	White Chocolate	White TX	White Velvet	White Woodgrain
Willow	Winter Fun			

Profile



Options

Frame	<ul style="list-style-type: none"> •See page 22 for JBC supplied & installed insert options (Glass/Leather/Mesh) •2.25" stiles and rails standard •Adhesive only if customer is supplying and installing an insert
Sizing	<ul style="list-style-type: none"> •Minimum Size (Doors): 7" x 7" •Maximum Size (Doors): 46" x 94" •Minimum Size (Dwrs): 5-7/8" x 5-7/8" •Maximum Size (Dwrs): 94" x 46"

Umbria



Finishes



Aliso



Alno



Antique White



Black



Celadon



Mysterious



Weekend Getaway



White Chocolate

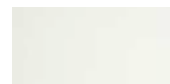

White TX

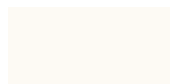

White Velvet



White Woodgrain

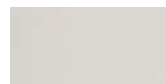

Willow



Winter Fun

Profile



Options

Frame

- See page 22 for JBC supplied & installed insert options (Glass/Leather/Mesh)
- 2.5" stiles and rails standard
- Adhesive only if customer is supplying and installing an insert

Sizing

- Minimum Size (Doors): 7" x 7"
- Maximum Size (Doors): 46" x 94"
- Minimum Size (Dwrs): 6-3/8" x 6-3/8"
- Maximum Size (Dwrs): 94" x 46"

5 P C

PROFILES & SPECIFICATIONS

Venice



Finishes



Chameleon



Fashionista



First Class



Free Spirit



Rhapsody



Sheer Beauty

Profile



Options

Frame

- See page 22 for JBC supplied & installed insert options (Glass/Leather/Mesh)
- 2.25" stiles and rails standard
- Adhesive only if customer is supplying and installing an insert

Sizing

- Minimum Size (Doors): 7" x 7"
- Maximum Size (Doors): 46" x 94"
- Minimum Size (Dwrs): 5-7/8" x 5-7/8"
- Maximum Size (Dwrs): 94" x 46"

Tuscany



Finishes



Chameleon



Fashionista



First Class



Free Spirit



Rhapsody



Sheer Beauty

Profile



Options

Frame

- See page 22 for JBC supplied & installed insert options (Glass/Leather/Mesh)
- 2.25" stiles and rails standard
- Adhesive only if customer is supplying and installing an insert

Sizing

- Minimum Size (Doors): 7" x 7"
- Maximum Size (Doors): 46" x 94"
- Minimum Size (Dwrs): 5-7/8" x 5-7/8"
- Maximum Size (Dwrs): 94" x 46"

5 P C

PROFILES & SPECIFICATIONS

Amalfi



Finishes



Free Spirit



Rhapsody

Profile



Options

Frame

- Not Available with inserts (glass/mesh/leather)
- See Tuscany model for insert compatibility

Sizing

- Minimum Size (Doors): 7" x 7"
- Maximum Size (Doors): 46" x 94"
- Minimum Size (Dwrs): 5-7/8" x 5-7/8"
- Maximum Size (Dwrs): 94" x 46"



INSERTS

3DL OR 5PC CRAFTSMAN

Glass



Leather



JBC makes door inserts easy and beautiful! Glass, leather or mesh is available to be inserted into our 3DL or 5PC Craftsman product lines. Having JBC do the insertion avoids pickup and delivery fees to from your local glass or insert company. All glass is tempered for safety. Give your team one less item to prep for installation.



Bright White Buffalo



Paloma Grey Buffalo



Grey Umber Buffalo



Coal Buffalo



Grey Stone Shagreen



Cocoa Shagreen



Pebble Shagreen

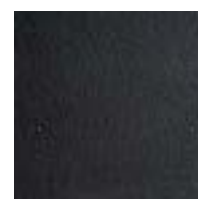

Black Shagreen

These are inserts that work!

INSERTS

3DL OR 5PC CRAFTSMAN

Mesh



Metro



Flat Black



Satin Brass (pictured)



Satin Nickel

Tweed

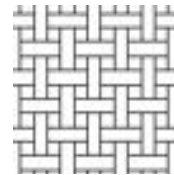

Flat Black



Satin Brass



Antique Brass

Creel

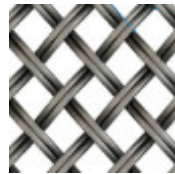

Flat Black



Satin Brass



Satin Nickel

Chevron

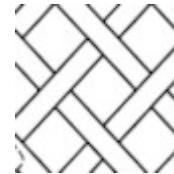

Flat Black



Satin Brass



Satin Nickel



ARTISAN



**Material | TFL
(Thermally Fused
Laminate)**

**Profiles | 5 PC Shaker,
3 PC, and Slab**
JBC's line of exact
match TFL doors and
drawers. 90 degree
shakers, 3pc or slabs
are available. Stiles
and rails are edge
banded TFL.

Naples



Finishes



After Hours



Aliso



Alno



Apres Ski



Casting @ 1st Lt



Chameleon



Fashionista



First Class



Free Spirit



Rhapsody



Sheer Beauty



Sunset Cruise



Weekend Getaway



Winter Fun

Profile



Options

Frame

- Frame is available, no insert supplied or installed
- 2-1/8" stiles and rails standard
- Adhesive only if customer is supplying and installing an insert

Sizing

- Minimum Size (Doors): 7" x 7"
- Maximum Size (Doors): 48" x 96"
- Minimum Size (Dwrs): 5-7/8" x 5-7/8"
- Maximum Size (Dwrs): 96" x 48"

3PC

PROFILES & SPECIFICATIONS

Lugano



Finishes



After Hours



Aliso



Alno



Apres Ski



Casting @ 1st Lt



Chameleon



Fashionista



First Class



Free Spirit



Rhapsody



Sheer Beauty



Sunset Cruise



Weekend Getaway



Winter Fun

Profile

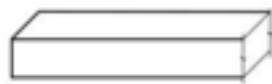

Options

Frame

- Frame is not available
- 2-3/4" stiles standard

Sizing

- Minimum Size (Doors): 7" x 7"
- Maximum Size (Doors): 48" x 48"
- Minimum Size (Dwrs): 5-7/8" x 5-7/8"
- Maximum Size (Dwrs): 48" x 48"

Capri



Finishes



After Hours



Aliso



Alno



Apres Ski



Casting @ 1st Lt



Chameleon



Fashionista



First Class



Free Spirit



Rhapsody



Sheer Beauty



Sunset Cruise



Weekend Getaway



Winter Fun

Profile

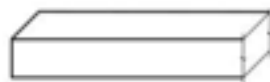

Options

Frame

- See Naples profile for frame options
- 2-1/8" stiles and rails standard

Sizing

- Minimum Size (Doors): 7" x 7"
- Maximum Size (Doors): 48" x 96"
- Minimum Size (Dwrs): 5-7/8" x 5-7/8"
- Maximum Size (Dwrs): 96" x 48"



CONTACT US

JB Cutting, Inc.
171 Grand Avenue, Mt. Clemens, MI 48043
Support: 586-468-4765
support@jbcutting.com
www.jbcutting.com | 586.468.4765

